

Article number: 604140010009

Description: Timing belt pulley with hub
HTD 10 3M 9

Measures

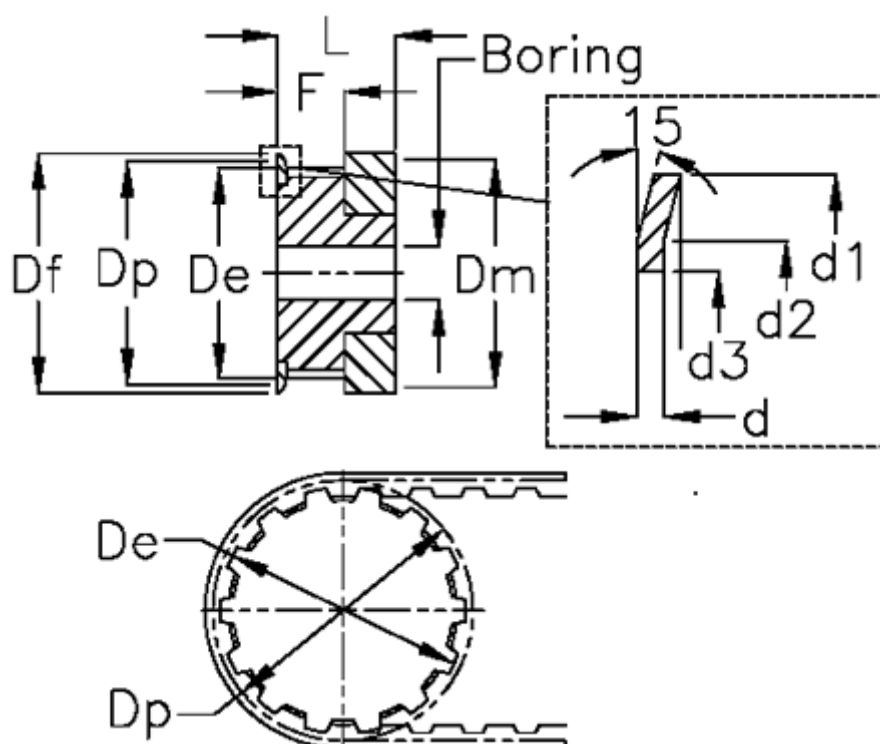

Bore = 4	Dp	= 9.55
d = 0.5	F	= 10.2
d1 = 13	Flange type	= F01
d2 = 10	L	= 17.5
d3 = 6	Tooth number	= 10
De = 8.79	Type	= 3M
Df = 13	Weight	= 0.004
Dm = 13	Width	= 09